

## Flow Measurement

### SITRANS F M

#### Flow sensor MAG 1100 F

#### Overview



The electromagnetic sensor SITRANS F M MAG 1100 F is designed to meet applications in the food and beverage industry.

#### Benefits

- Sensor sizes: DN 10 to DN 100 (3/8" to 4")
- AISI 316 stainless steel enclosure
- Sensor: Hygienic connection, 3A approval and EHEDG certified
- Sanitary design for CIP / SIP cleaning
- Easy commissioning, the SENSORPROM unit automatically updates settings
- Hose proof IP67/NEMA 4X enclosure rating
- Designed that patented in-situ verification can be conducted. Using SENSORPROM fingerprints

#### Application

The main applications of the SITRANS F M electromagnetic sensors can be found in the following fields:

- Food industry
- Beverage industry
- Pharmaceutical industry

#### Design

- Unique mechanical design with a wide range of customer specified sanitary connection
- Compact or remote mounting possible easy "plug & play" field changeable
- Simple on site upgrade to IP68/NEMA 6P terminal box
- ATEX 2G D version for hazardous areas (ceramic liner)

#### Mode of operation

The flow measuring principle is based on Faraday's law of electromagnetic induction according to which the sensor converts the flow into an electrical voltage proportional to the velocity of the flow.

#### Integration

The complete flowmeter consists of a sensor and an associated transmitter SITRANS F M MAG 5000, 6000 and 6000 I. The flexible communication concept USM II simplifies integration and update to a variety of fieldbus systems such as PROFIBUS DP and PA, Modbus RTU/RS 485, HART, FOUNDATION Fieldbus H1, DeviceNet.

#### Pressure/temperature curve; material AISI 316L/1.4404

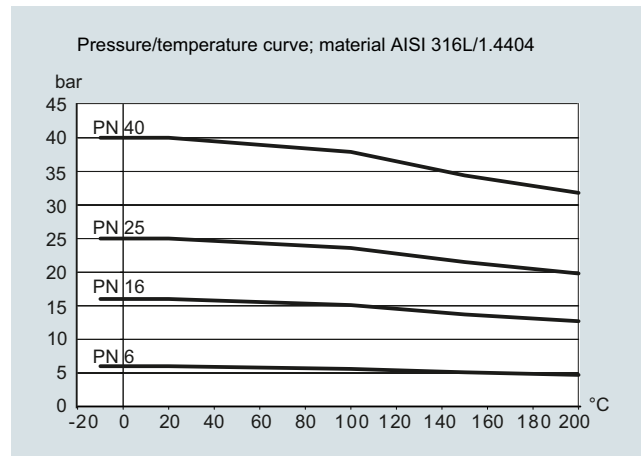

#### Pressure/temperature curve; material AISI 316L/1.4404

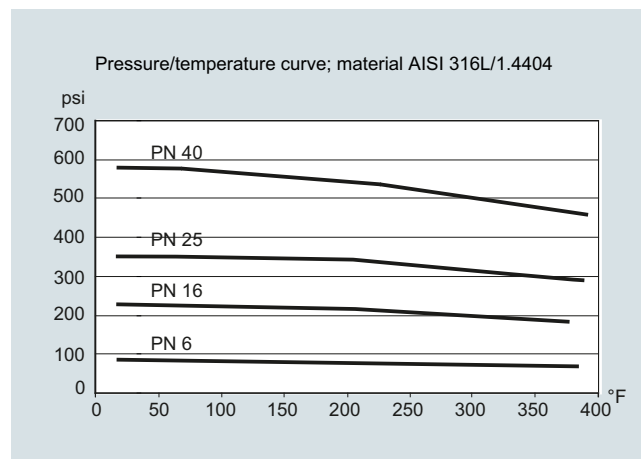

For further information on the PED standard and requirements, see page 10/15.

## Technical specifications

<b>Measuring principle</b> Excitation frequency (Mains supply: 50 Hz/60 Hz)	Electromagnetic induction DN 10 ... 65 (¾" ... 2½"): 12.5 Hz/15 Hz DN 80 ... 100 (3", 4"): 6.25 Hz/7.5 Hz	<b>Design</b> Weight See Dimensional drawings
<b>Process connection</b> Nominal size Process connection	DN 10 ... DN 100 (¾" ... 4") Hygienic adapters available for: • Direct welding onto pipe • Clamp fitting • Threaded fitting	<b>Material</b> Enclosure • MAG 1100 F Stainless steel AISI 316L/1.4404 Terminal box (remote version only) • Standard Fibre glass reinforced polyamide Stainless steel AISI 316/1.4436 • Option Stainless steel AISI 316/1.4436 • Ex ATEX (remote version only)
<b>Rated operating conditions</b> <u>Ambient conditions</u> Ambient temperature • Sensor • Ex sensor • Compact with transmitter MAG 5000/6000 • Compact with transmitter MAG 6000 I • Compact with transmitter MAG 6000 I Ex	-40 ... +100 °C (-40 ... +212 °F) -20 ... +60 °C (-4 ... +140 °F) -20 ... +60 °C (-4 ... +140 °F) -20 ... +60 °C (-4 ... +140 °F) -20 ... +60 °C (-4 ... +140 °F)	<b>Liner</b> MAG 1100 F (Ceramic) Aluminum oxide Al <sub>2</sub> O <sub>3</sub> (ceramics) MAG 1100 F (PFA) Reinforced PFA (teflon) (not for Ex)
<u>Temperature of medium</u> MAG 1100 F (Ceramic) MAG 1100 F (PFA)	-20 ... +150 °C (-4 ... +302 °F) Suitable for steam sterilization -30 ... +130 °C (-22 ... +266 °F) Suitable for steam sterilization at 150 °C (302 °F)	<b>Electrodes</b> MAG 1100 F (Ceramic) Platinum with gold /Titanium brazing alloy MAG 1100 F (PFA) • DN 10 ... 15 (¾" ... ½"): Hastelloy C276/2.4819 • DN 25 ... 100 (1" ... 4"): Hastelloy C22/2.4602
<u>Temperature shock</u> MAG 1100 F • Duration ≤ 1 min, followed by 10 min rest	• DN 10, 15, 25: Max. ΔT ≤ 80 °C/min (¾", ½", 1"): Max. ΔT ≤ 144 °F/min) • DN 40, 50, 65: Max. ΔT ≤ 70 °C/min (1½", 2", 2½"): Max. ΔT ≤ 126 °F/min) • DN 80, 100: Max. ΔT ≤ 60 °C/min (3", 4"): Max. ΔT ≤ 108 °F/min) Max. ± 100 °C (212 °F) momentar- ily	<b>Cable entries</b> • Remote installation 2 x M20 or 2 x ½" NPT • Compact installation - MAG 5000/MAG 6000: 4 x M20 or 4 x ½" NPT - MAG 6000 I: 2 x M25 (for sup- ply/output) - MAG 6000 I Ex: 2 x M25 (for supply/output)
<u>Operating pressure</u> MAG 1100 F (Ceramic) MAG 1100 F (PFA)	DN 10 ... 65: 40 bar (¾" ... 2½"): 580 psi) DN 80: 25 bar (3": 363 psi) DN 100: 25 bar (4": 363 psi) Vacuum: 1 x 10 <sup>-6</sup> bar <sub>abs</sub> (1.5 x 10 <sup>-5</sup> psi <sub>abs</sub> ) 20 bar (290 psi) Vacuum: 0.02 bar <sub>abs</sub> (0.3 psi <sub>abs</sub> ) DN 80 ... DN 100: CO <sub>2</sub> pressure max. 7 bar (101.5 psi)	<b>Certificates and approvals</b> Calibration • Standard production calibration Zero-point, 2 x 25 %, 2 x 90 % Hazardous area • MAG 1100 F (Ceramic) - Ex-sensor in compact or remote version with MAG 6000 I Ex ATEX, EAC Ex - Zone 1 Ex d e ia IIB T6 Gb ATEX - Zone 21 Ex tD A21 IP67 FM - NI Class I Div. 2 Groups A, B, C, D MAG 1100 F (PFA) - Standard sensor in compact or remote version with MAG 5000/6000/6000 I FM - NI Class I Div. 2 Groups A, B, C, D
<u>Mechanical load (vibration)</u>	18 ... 1000 Hz random in x, y z, directions for 2 hours according to EN 60068-2-36 Sensor: 3.17 g RMS Sensor with compact MAG 5000/ 6000 mounted transmitter: 3.17 g RMS. Sensor with compact MAG 6000 I/MAG 6000 I Ex mounted transmitter: 1.14 g RMS For compact installation with the MAG 6000 I/MAG 6000 I Ex, trans- mitter to be supported to avoid tension on sensor part.	Hygienic • MAG 1100 F (Ceramic) 3A (remote version with Polyam- ide terminal box) • MAG 1100 F (PFA) 3A (remote version with Polyam- ide terminal box) EHEDG (remote version with Poly- amide terminal box, DN 25 ... 100/1 ... 4") Hygienic EC 1935:2004 European food contact material Pressure Equipment PED - 2014/68/EU Others EAC (Russia, Belarus, Kazakhstan) KCC (South Korea)
<u>Enclosure rating</u> EMC	IP67 to EN 60529 (NEMA 4X), 1 mH <sub>2</sub> O for 30 min 2014/30/EU	

# Flow Measurement

## SITRANS F M

### Flow sensor MAG 1100 F

#### Accessories

##### Weld-in adapter

Adapter for welding onto dairy pipe, stainless steel 1.4404

- DN 10, 15, 25, 40, 50 and 65 (3/8", 1/2", 1", 1 1/2", 2" and 2 1/2")
- DN 80 and DN 100 (3" and 4")

Tri-Weld, ISO 2037, DIN 11850, SMS 3008, BS 4825-1

PN 40 (600 psi)

PN 25 (350 psi)

##### Clamp adapter

DN 10, 15, 25, 40 and 50 (3/8", 1/2", 1", 1 1/2", and 2")

DN 65, 80 and 100 (2 1/2", 3" and 4")

Tri-Clamp, ISO 2852, DIN 32676, SMS 3016, BS 4825-3

PN 16 (200 psi)

PN 10 (150 psi)

##### Thread adapter

DIN 11851

- DN 10, 15, 25, and 40 (3/8", 1/2", 1", and 1 1/2")

PN 40 (600 psi)

- DN 50, 65, 80 and 100 (2", 2 1/2", 3" and 4")

PN 25 (350 psi)

ISO 2853, BS 4825-4

- DN 10, 15, 25, 40, 50, 65 and 80 (3/8", 1/2", 1", 1 1/2", 2", 2 1/2" and 3")

PN 16 (200 psi)

SMS 1145

- DN 25, 40, 50, 65 and 80 (1", 1 1/2", 2", 2 1/2" and 3")

PN 6 (80 psi)

#### Design

##### Material

Adapter

Stainless steel AISI 316/1.4436

Gasket

- MAG 1100 F (Ceramic)

FKM/FPM with stainless steel insert (AISI 304/1.4301) (-20 ... +150 °C (-4 ... +302 °F))

EPDM (-20 ... +150 °C (-4 ... +302 °F))

- MAG 1100 F (PFA)

EPDM (-20 ... +150 °C (-4 ... +302 °F))

NBR (-20 ... +100 °C (-4 ... +212 °F))

#### Note:

When combined sensor and adapter, the operating pressure is the lower rated of the pair.

#### Selection and Ordering data

##### Sensor SITRANS F M MAG 1100 F

Article No.

7 ME 6 1 4 0 -

Click on the Article No. for the online configuration in the PIA Life Cycle Portal.

##### Diameter

DN 10 (3/8")

1 R

DN 15 (1/2")

1 V

DN 25 (1")

2 D

DN 40 (1 1/2")

2 R

DN 50 (2")

2 Y

DN 65 (2 1/2")

3 F

DN 80 (3")

3 M

DN 100 (4")

3 T

##### Process connections

None (not suitable for 3A approval)

A

##### Weld in

DIN 11850

B

ISO 2037 (SMS 3008)

C

Tri-Weld/BS 4825-1

D

##### Clamp type

DIN 32676

G

ISO 2852 (SMS 3016)

H

Tri-Clamp/BS 4825-3

J

##### Threaded type

DIN 11851

M

SMS 1145<sup>1)</sup>

N

##### Liner material

PFA

1

Ceramic

2

##### Gasket material<sup>1)</sup>

EPDM flat gasket (3A)

0

FPM/FKM (3A) (only with ceramic liner)

2

EPDM-P gasket (only for PFA) (EHEDG, 3A)

3

##### Electrode material

Hastelloy C (only with PFA liner)

1

Platinum (only with ceramic liner)

2

##### Transmitter

Standard sensor for remote transmitter (order transmitter separately), 3A approved

A

Ex sensor for remote transmitter (order transmitter separately) 3A approved

B

MAG 6000 I, Alu.18 ... 90 V DC, 115 ... 230 V AC

C

MAG 6000 I, Aluminum 18 ... 30 V DC, Ex

D

MAG 6000 I, Aluminum 115 ... 230 V AC, Ex

E

MAG 6000, Polyamide, 11 ... 30 V DC/11 ... 24 V AC

H

MAG 6000, Polyamide, 115 ... 230 V AC

J

MAG 5000, Polyamide, 11 ... 30 V DC/11 ... 24 V AC

K

MAG 5000, Polyamide, 115 ... 230 V AC

L

##### Communication

No communication, add-on possible

A

HART

B

PROFIBUS PA Profile 3

F

(only MAG 6000/MAG 6000 I)

PROFIBUS DP Profile 3 (not for Ex)

G

(only MAG 6000/MAG 6000 I)

Modbus RTU/RS 485 (not for Ex)

E

(only MAG 6000/MAG 6000 I)

FOUNDATION Fieldbus H1

J

(only MAG 6000/MAG 6000 I)

<sup>1)</sup> SMS 1145 standard is not approved by 3A

Selection and Ordering data	Article No.
<b>Sensor SITRANS F M MAG 1100 F</b>	<b>7 ME 6 1 4 0 -</b>
	
<b>Cable glands/terminal box</b>	
Metric: Polyamide terminal box or MAG 6000 I compact	1
½" NPT: Polyamide terminal box or MAG 6000 I compact	2
Metric: Stainless steel terminal box	3
½" NPT: Stainless steel terminal box	4

Selection and Ordering data	Order code
<b>Additional information</b>	
Please add <b>"-Z"</b> to Article No. and specify Order code(s) and plain text.	
<b>Certificates</b>	
Pressure test certificate according to EN 10204-3.1	<b>C01</b>
Material certificate according to EN 10204-3.1	<b>C12</b>
Factory certificate according to EN 10204-2.2	<b>C14</b>
Factory certificate according to EN 10204-2.1	<b>C15</b>
<b>Terminal blocks</b>	
• Factory mounted terminal blocks	<b>N02</b>
<b>Region/customer specific labels</b>	
• KCC label (South Korea)	<b>W28</b>
Tag name plate, stainless steel (specify in plain text)	<b>Y17</b>
Tag name plate, plastic (self adhesive)	<b>Y18</b>
Customer-specific transmitter setting	<b>Y20</b>
Sensor cables wired (specify Article No. for sensor cables and order cables separately)	<b>Y40</b>
Sensor cables wired and IP68 sealing (specify Article No. for sensor cables and order cables separately)	<b>Y41</b>
Special version (specify in plain text)	<b>Y99</b>
<b>Additional calibrations</b>	
• Matched pair - (Standard production calibration where sensor and transmitter is calibrated together)	<b>On request<sup>1)</sup></b>
• Accredited Siemens Flow Instruments matched pair Calibration acc. to ISO/IEC 17025: 2005	<b>On request<sup>1)</sup></b>
• Customer-specified calibration up to 10 points	<b>On request<sup>1)</sup></b>
• Customer-witnessed calibration Any of above calibration	<b>On request<sup>1)</sup></b>

<sup>1)</sup> Product Variation Request (PVR)

### Operating instructions for SITRANS F M MAG 1100F

Description	Article No.
• English	<b>A5E02435647</b>
All literature is available to download for free, in a range of languages, at <a href="http://www.siemens.com/processinstrumentation/documentation">www.siemens.com/processinstrumentation/documentation</a>	
Please use online Product selector to get latest updates. Product selector link: <a href="http://www.pia-portal.automation.siemens.com">www.pia-portal.automation.siemens.com</a>	

### Accessories

Description	Article No.
Potting kit for IP68/ NEMA 6P sealing of sensor junction box	<b>FDK:085U0220</b>
	

# Flow Measurement

## SITRANS F M

### Flow sensor MAG 1100 F

#### Accessories for MAG 1100 F sensor

Article No.

##### Weld-in connection fittings for use with P gaskets (Stainless steel)

Material: AISI 316L (1.4404)

Only for liner PFA

2 pcs. fittings

2 pcs. clamps (to join flow sensor and fitting),

P gaskets not included

##### DIN 11850<sup>1)</sup>

Adapter			Sensor
DN (mm)	D <sub>o</sub> (mm)	D <sub>T</sub> (mm)	DN (mm)

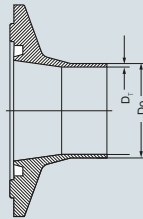

10 <sup>2)</sup>	13	1.5	10	<b>A5E02054630</b>
15 <sup>2)</sup>	19	1.5	15	<b>A5E02054633</b>
20	23	1.5	15	<b>A5E02054634</b>
25	29	1.5	25	<b>A5E02054635</b>
32	35	1.5	25	<b>A5E02054637</b>
40	41	1.5	40	<b>A5E02054638</b>
50	53	1.5	50	<b>A5E02054640</b>
65	70	2.0	65	<b>A5E02054643</b>
80	85	2.0	80	<b>A5E02054644</b>
100	104	2.0	100	<b>A5E02054646</b>

##### ISO 2037<sup>1)</sup>

Adapter			Sensor	
DN (mm)	D <sub>o</sub> (mm)	D <sub>T</sub> (mm)	DN (mm)	
12.7	12.7	1.0	10	<b>A5E03727946</b>
17.2	17.2	1.0	15	<b>A5E03728098</b>
25	25	1.6	25	<b>A5E02196073</b>
33	33.7	1.6	25	<b>A5E02196074</b>
38	38	1.6	40	<b>A5E02196075</b>
40	40	1.6	40	<b>A5E02196076</b>
51	51	1.6	50	<b>A5E02196077</b>
63.5	63.5	1.6	65	<b>A5E02196078</b>
76.1	76.1	1.6	80	<b>A5E02196080</b>
101.6	101.6	2.0	100	<b>A5E02196082</b>

##### Tri-Weld (BS 4825-1)<sup>1)</sup>

Adapter			Sensor	
DN (mm)	D <sub>o</sub> (mm)	D <sub>T</sub> (mm)	DN (mm)	
12.7	12.7	1.2	10	<b>A5E02199113</b>
19.05	19.05	1.2	15	<b>A5E02199114</b>
25.4	25.4	1.6	25	<b>A5E02199115</b>
38.1	38.1	1.6	40	<b>A5E02199116</b>
50.8	50.8	1.6	50	<b>A5E02199117</b>
63.5	63.5	1.6	65	<b>A5E02199118</b>
76.2	76.2	1.6	80	<b>A5E02199119</b>
101.6	101.6	2.0	100	<b>A5E02199120</b>

#### Accessories for MAG 1100 F sensor

Article No.

##### Clamp-type connection fittings for use with P gaskets (Stainless steel)

Material: AISI 316L (1.4404)

Only for liner PFA

2 pcs. fittings

2 pcs. clamps (to join flow sensor and fitting),

P gaskets not included

##### DIN 32676<sup>1)</sup>

Adapter			Sensor
DN (mm)	D <sub>o</sub> (mm)	D <sub>i</sub> (mm)	DN (mm)

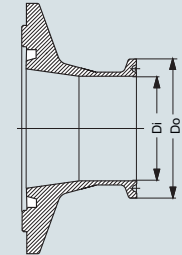

10	34	10	10	<b>A5E02211143</b>
15	34	16	15	<b>A5E02211144</b>
25	50.5	22.6	25	<b>A5E02211146</b>
40	50.5	38	40	<b>A5E02211147</b>
50	64	50	50	<b>A5E02211148</b>
65	91	66	65	<b>A5E02211151</b>
80	106	81	80	<b>A5E02211152</b>
100	119	100	100	<b>A5E02211153</b>

##### ISO 2852<sup>1)</sup>

Adapter			Sensor	
DN (mm)	D <sub>o</sub> (mm)	D <sub>i</sub> (mm)	DN (mm)	
25	50.5	22.6	25	<b>A5E02213581</b>
33.7	50.5	31.3	25	<b>A5E02213582</b>
38	50.5	35.6	40	<b>A5E02213583</b>
51	64	48.6	50	<b>A5E02213584</b>
63.5	77.5	60.3	65	<b>A5E02213585</b>
76.1	91	72.9	80	<b>A5E02213586</b>
101.6	119	97.6	100	<b>A5E02213587</b>

##### Tri-Clamp (BS 4825-3)<sup>1)</sup>

Adapter			Sensor	
DN (mm)	D <sub>o</sub> (mm)	D <sub>i</sub> (mm)	DN (mm)	
12.7	25.4	9.5	10	<b>A5E02213596</b>
19.05	25.4	15.85	15	<b>A5E02213597</b>
25.4	50.5	22.2	25	<b>A5E02213598</b>
38.1	50.5	34.9	40	<b>A5E02213599</b>
50.8	64	47.6	50	<b>A5E02213600</b>
63.5	77.5	60.3	65	<b>A5E02213601</b>
76.2	91	73	80	<b>A5E02213602</b>
101.6	119	97.6	100	<b>A5E02213603</b>

D<sub>o</sub>: Outer diameterD<sub>i</sub>: Inner diameter<sup>1)</sup> Suitable for EHEDG<sup>2)</sup> Not suitable for EHEDG

**Accessories for MAG 1100 F sensor** Article No.**Threaded type connection fittings for use with P gaskets (Stainless steel)**

Material: AISI 316L (1.4404)

Only for liner PFA

2 pcs. fittings

2 pcs. clamps (to join flow sensor and fitting),

P gaskets not included

**DIN 11851<sup>1)</sup>**

Adapter		Sensor	
DN (mm)	D <sub>o</sub> (mm)	D <sub>i</sub> (mm)	DN (mm)

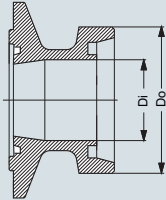

10	28	10	10	<b>A5E02218293</b>
15	34	16	15	<b>A5E02218294</b>
20	44	20	15	<b>A5E02218295</b>
25	52	26	25	<b>A5E02218296</b>
32	58	32	25	<b>A5E02218297</b>
40	65	38	40	<b>A5E02218298</b>
50	78	50	50	<b>A5E02218299</b>
65	95	66	65	<b>A5E02218300</b>
80	110	81	80	<b>A5E02218301</b>
100	130	100	100	<b>A5E02218302</b>

**Accessories for MAG 1100 F sensor** Article No.**Threaded type connection fittings for use with P gaskets (Stainless steel)**

Material: AISI 316L (1.4404)

Only for liner PFA

2 pcs. fittings

2 pcs. clamps (to join flow sensor and fitting),

P gaskets not included

**SMS 1145<sup>1)</sup>**

Adapter		Sensor	
DN (mm)	D <sub>o</sub> (mm)	D <sub>i</sub> (mm)	DN (mm)

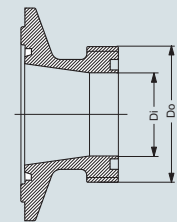

25	40	22.6	25	<b>A5E02218310</b>
38	60	35.6	40	<b>A5E02218312</b>
51	70	48.6	50	<b>A5E02218313</b>
63.5	85	60.3	65	<b>A5E02218314</b>
76	98	72	65	<b>A5E02218315</b>

D<sub>o</sub>: Outer diameterD<sub>i</sub>: Inner diameter<sup>1)</sup> Suitable for EHEDG

# Flow Measurement

## SITRANS F M

### Flow sensor MAG 1100 F

#### Accessories for MAG 1100 F sensor Article No.

##### Weld-in connection fittings for use with flat gaskets (Stainless steel)

Material: AISI 316L (1.4404)  
For liner PFA and ceramic  
2 pcs. fittings  
2 pcs. clamps (to join flow sensor and fitting),  
Flat gaskets not included

##### DIN 11850<sup>1)</sup>

Adapter			Sensor
DN (mm)	D <sub>o</sub> (mm)	D <sub>T</sub> (mm)	DN (mm)

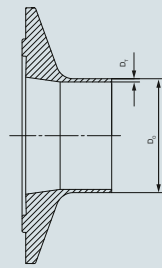

10	13	1.5	10	<b>FDK:083G2116</b>
15	19	1.5	15	<b>FDK:083G2117</b>
20	23	1.5	15	<b>FDK:083G2118</b>
25	29	1.5	25	<b>FDK:083G2119</b>
32	35	1.5	25	<b>FDK:083G2120</b>
40	41	1.5	40	<b>FDK:083G2121</b>
50	53	1.5	50	<b>FDK:083G2122</b>
65	70	2.0	65	<b>FDK:083G2123</b>
80	85	2.0	80	<b>FDK:083G2124</b>
100	104	2.0	100	<b>FDK:083G2125</b>

##### ISO 2037<sup>1)</sup>

Adapter			Sensor
DN (mm)	D <sub>o</sub> (mm)	D <sub>T</sub> (mm)	DN (mm)

12.7	12.7	1.0	10	<b>A5E03720273</b>
17.2	17.2	1.0	15	<b>FDK:083G2107</b>
25	25.6	1.6	25	<b>FDK:083G2109</b>
33.7	33.7	1.6	25	<b>FDK:083G2100</b>
38	38	1.6	40	<b>FDK:083G2111</b>
40	40	1.6	40	<b>FDK:083G2101</b>
51	51	1.6	50	<b>FDK:083G2112</b>
63.5	63.5	1.6	65	<b>FDK:083G2113</b>
76.1	71.1	1.6	80	<b>FDK:083G2114</b>
101.6	101.6	2.0	100	<b>FDK:083G2115</b>
114.3	118.3	2.0	100	<b>FDK:083G2105</b>

##### Tri-Weld (BS 4825-1)<sup>1)</sup>

Adapter			Sensor
DN (mm)	D <sub>o</sub> (mm)	D <sub>T</sub> (mm)	DN (mm)

12.7	12.7	1.2	10	<b>FDK:083G2276</b>
19.05	19.05	1.2	15	<b>FDK:083G2277</b>
25.4	25.4	1.6	25	<b>FDK:083G2279</b>
38	38.1	1.6	40	<b>FDK:083G2281</b>
50.8	50.8	1.6	50	<b>FDK:083G2282</b>
63.5	63.5	1.6	65	<b>FDK:083G2283</b>
76.2	76.2	1.6	80	<b>FDK:083G2284</b>
101.6	101.6	2.0	100	<b>FDK:083G2285</b>

#### Accessories for MAG 1100 F sensor Article No.

##### Clamp-type connection fittings for use with flat gaskets (Stainless steel)

Material: AISI 316L (1.4404)  
For liner PFA and ceramic  
2 pcs. fittings  
2 pcs. clamps (to join flow sensor and fitting),  
Flat gaskets not included

##### DIN 32676<sup>1)</sup>

Adapter			Sensor
DN (mm)	D <sub>o</sub> (mm)	D <sub>T</sub> (mm)	DN (mm)

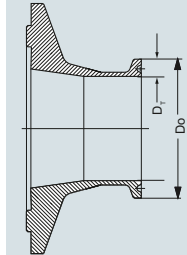

10	34	10	10	<b>FDK:083G2186</b>
15	34	16	15	<b>FDK:083G2187</b>
25	50.5	26	25	<b>FDK:083G2179</b>
40	50.5	38	40	<b>FDK:083G2181</b>
50	64	50	50	<b>FDK:083G2182</b>
65	91	66	65	<b>FDK:083G2183</b>
80	106	81	80	<b>FDK:083G2184</b>
100	119	100	100	<b>FDK:083G2185</b>

##### ISO 2852<sup>1)</sup>

Adapter			Sensor
DN (mm)	D <sub>o</sub> (mm)	D <sub>T</sub> (mm)	DN (mm)

25	50.5	22.6	25	<b>FDK:083G2189</b>
33.7	50.5	31.3	25	<b>FDK:083G2190</b>
38	50.5	35.6	40	<b>FDK:083G2191</b>
51	64	48.6	50	<b>FDK:083G2192</b>
63.5	77.5	60.3	65	<b>FDK:083G2193</b>
76.1	91	72.9	80	<b>FDK:083G2194</b>
101.6	119	97.6	100	<b>FDK:083G2195</b>

##### Tri-Clamp (BS 4825-3)<sup>1)</sup>

Adapter			Sensor
DN (mm)	D <sub>o</sub> (mm)	D <sub>T</sub> (mm)	DN (mm)

12.7	25.4	9.5	10	<b>FDK:083G2286</b>
19.05	25.4	15.85	15	<b>FDK:083G2287</b>
25.4	50.5	22.2	25	<b>FDK:083G2289</b>
38.1	50.5	34.9	40	<b>FDK:083G2291</b>
50.8	64	47.6	50	<b>FDK:083G2292</b>
63.5	77.5	60.3	65	<b>FDK:083G2293</b>
76.2	91	73	80	<b>FDK:083G2294</b>
101.6	119	97.6	100	<b>FDK:083G2295</b>

D<sub>o</sub>: Outer diameter

D<sub>i</sub>: Inner diameter

<sup>1)</sup> Suitable for 3A

**Accessories for MAG 1100 F sensor** Article No.

**Threaded type connection fittings for use with flat gaskets (Stainless steel)**

Material: AISI 316L (1.4404)  
 For liner PFA and ceramic  
 2 pcs. fittings  
 2 pcs. clamps (to join flow sensor and fitting),  
 Flat gaskets not included

**DIN 11851<sup>1)</sup>**

Adapter			Sensor
DN (mm)	D <sub>o</sub> (mm)	D <sub>i</sub> (mm)	DN (mm)

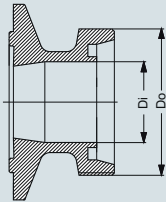

10	28	10	10	<b>FDK:083G2156</b>
15	34	16	15	<b>FDK:083G2157</b>
20	44	20	15	<b>FDK:083G2158</b>
25	52	26	25	<b>FDK:083G2159</b>
32	58	32	25	<b>FDK:083G2160</b>
40	65	38	40	<b>FDK:083G2161</b>
50	78	50	50	<b>FDK:083G2162</b>
65	95	66	65	<b>FDK:083G2163</b>
80	110	81	80	<b>FDK:083G2164</b>
100	130	100	100	<b>FDK:083G2165</b>

**ISO 2853<sup>1)</sup>**

Adapter			Sensor
DN (mm)	D <sub>o</sub> (mm)	D <sub>i</sub> (mm)	DN (mm)

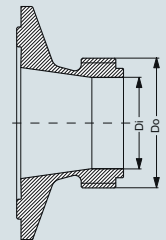

25	37	22.6	25	<b>FDK:083G2149</b>
38	51	35.6	40	<b>FDK:083G2151</b>
51	64	48.6	50	<b>FDK:083G2152</b>
63.5	78	60.3	65	<b>FDK:083G2153</b>
76.1	91	72.9	80	<b>FDK:083G2154</b>

**BS 4825-4<sup>1)</sup>**

Adapter			Sensor
DN (mm)	D <sub>o</sub> (mm)	D <sub>i</sub> (mm)	DN (mm)

101.6	126	97.6	100	<b>FDK:083G2145</b>
-------	-----	------	-----	---------------------

**Accessories for MAG 1100 F sensor** Article No.

**Threaded type connection fittings for use with flat gaskets (Stainless steel)**

Material: AISI 316L (1.4404)  
 For liner PFA and ceramic  
 2 pcs. fittings  
 2 pcs. clamps (to join flow sensor and fitting),  
 Flat gaskets not included

**SMS 1145<sup>2)</sup>**

Adapter			Sensor
DN (mm)	D <sub>o</sub> (mm)	D <sub>i</sub> (mm)	DN (mm)

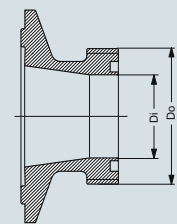

25	40	22.6	25	<b>FDK:083G2139</b>
38	60	35.6	40	<b>FDK:083G2141</b>
51	70	48.6	50	<b>FDK:083G2142</b>
63.5	85	60.3	65	<b>FDK:083G2143</b>
76	98	72	65	<b>FDK:083G2144</b>

D<sub>o</sub>: Outer diameter

D<sub>i</sub>: Inner diameter

<sup>1)</sup> Suitable for 3A

<sup>2)</sup> Not suitable for 3A



## Flow Measurement

### SITRANS F M

#### Flow sensor MAG 1100 F

##### Spare parts for MAG 1100 F sensor

Article No.

##### Gaskets

(delivered in pairs, to be placed between flow sensor and adapter)

##### MAG 1100 F (PFA) - P gaskets

Rubber: EPDM

• DN 10	<b>A5E02055286</b>
• DN 15	<b>A5E02055287</b>
• DN 25	<b>A5E02055290</b>
• DN 40	<b>A5E02055291</b>
• DN 50	<b>A5E02055292</b>
• DN 65	<b>A5E02055293</b>
• DN 80	<b>A5E02055295</b>
• DN 100	<b>A5E02055297</b>

##### MAG 1100 F (ceramic) - Flat gaskets

Rubber: FKM/FPM

• DN 10	<b>A5E00915707</b>
• DN 15	<b>A5E00915764</b>
• DN 25	<b>A5E00915771</b>
• DN 40	<b>A5E00915773</b>
• DN 50	<b>A5E00915775</b>
• DN 65	<b>A5E00915780</b>
• DN 80	<b>A5E00915782</b>
• DN 100	<b>A5E00915784</b>

##### MAG 1100 F (PFA, ceramic) - Flat gaskets

Rubber: EPDM

• DN 10	<b>FDK:083G2206</b>
• DN 15	<b>FDK:083G2207</b>
• DN 25	<b>FDK:083G2209</b>
• DN 40	<b>FDK:083G2211</b>
• DN 50	<b>FDK:083G2212</b>
• DN 65	<b>FDK:083G2213</b>
• DN 80	<b>FDK:083G2214</b>
• DN 100	<b>FDK:083G2215</b>

Rubber: NBR

• DN 10	<b>FDK:083G2216</b>
• DN 15	<b>FDK:083G2217</b>
• DN 25	<b>FDK:083G2219</b>
• DN 40	<b>FDK:083G2221</b>
• DN 50	<b>FDK:083G2222</b>
• DN 65	<b>FDK:083G2223</b>
• DN 80	<b>FDK:083G2224</b>
• DN 100	<b>FDK:083G2225</b>

**Dimensional drawings**

Sensor MAG 1100 F compact/remote

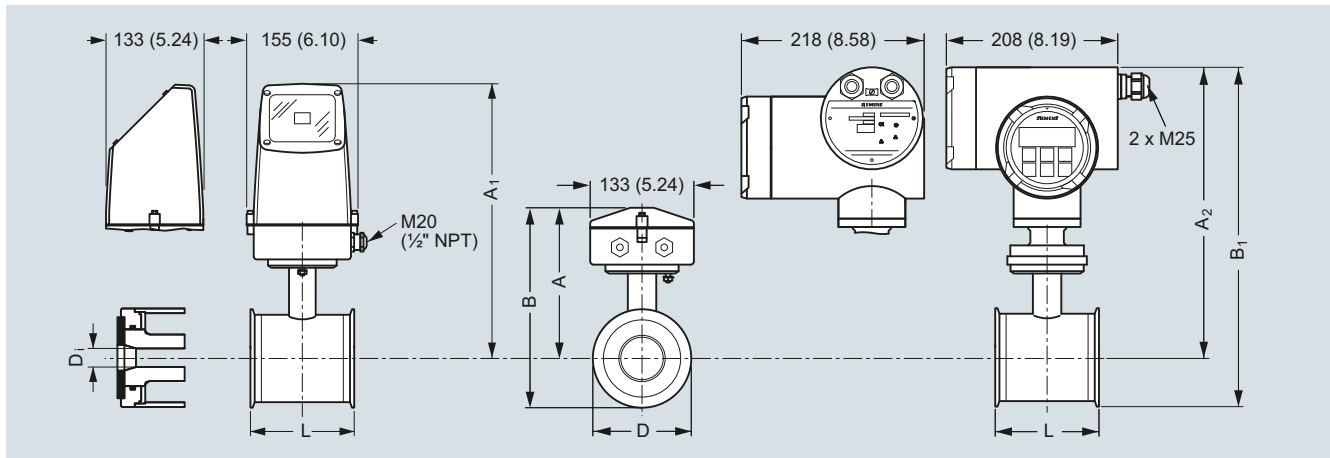

Dimensions in mm (inch)

**Important note:****For compact installation with MAG 6000 I/Ex - Supports the transmitter to avoid tension on the sensor part.**

Size	L	A	A <sub>1</sub> <sup>3)</sup>	B <sup>2)</sup>	B <sub>1</sub>	D	D <sub>1</sub> (Al <sub>2</sub> O <sub>3</sub> )	D <sub>1</sub> PFA	Weight <sup>1)</sup>
DN	[mm]	[mm]	[mm]	[mm]	[mm]	[mm]	[mm]	[mm]	[kg]
10	64	161	315	193.7	344.7	64.0	10	10	2.2
15	64	161	315	193.7	344.7	64.0	15	16	2.2
25	79	169	323	207.5	359.0	77.5	25	26	2.7
40	94	179	333	228.0	379.0	91.0	40	38	3.4
50	104	188	342	247.7	398.7	119.0	50	50	4.2
65	131	197.5	351	262.6	413.6	130.0	65	66	5.5
80	156	204	357	281.0	432.0	155.0	80	81	7.0
100	186	217	370	308.0	459.0	183.0	100	100	10.0

Size	L	A	A <sub>1</sub> <sup>3)</sup>	B <sup>2)</sup>	B <sub>1</sub>	D	D <sub>1</sub> (Al <sub>2</sub> O <sub>3</sub> )	D <sub>1</sub> PFA	Weight <sup>1)</sup>
[inch]	[inch]	[inch]	[inch]	[inch]	[inch]	[inch]	[inch]	[inch]	[lb]
3/8	2.52	6.34	12.40	7.62	13.57	2.52	0.39	0.39	4.8
1/2	2.52	6.34	12.40	7.62	13.57	2.52	0.59	0.63	4.8
1	3.11	6.66	12.72	8.17	14.13	3.05	0.98	1.02	4.9
1 1/2	3.70	7.05	13.11	8.98	14.92	3.58	1.57	1.50	7.5
2	4.09	7.40	13.47	9.75	15.70	4.68	1.97	1.97	9.2
2 1/2	5.16	7.78	13.82	10.34	16.28	5.12	2.56	2.60	12.0
3	6.14	8.03	14.06	11.06	17.01	6.10	3.15	3.19	15.0
4	7.32	8.54	14.57	12.13	18.07	7.20	3.94	3.94	22.0

<sup>1)</sup> With transmitter MAG 5000 or MAG 6000 compact, weight is increased by approximately 0.8 kg (1.8 lb)  
 With MAG 6000 I weight is increased with 5.5 kg ( 12.1 lb)

<sup>2)</sup> 14.5 mm (0.571") shorter when the stainless steel terminal box is used (always Ex version)

<sup>3)</sup> A<sub>2</sub> is 3 mm (0.12") shorter than A<sub>1</sub>

## Flow Measurement

### SITRANS F M

#### Flow sensor MAG 1100 F

Sensor MAG 1100 F compact/separate – built-in length

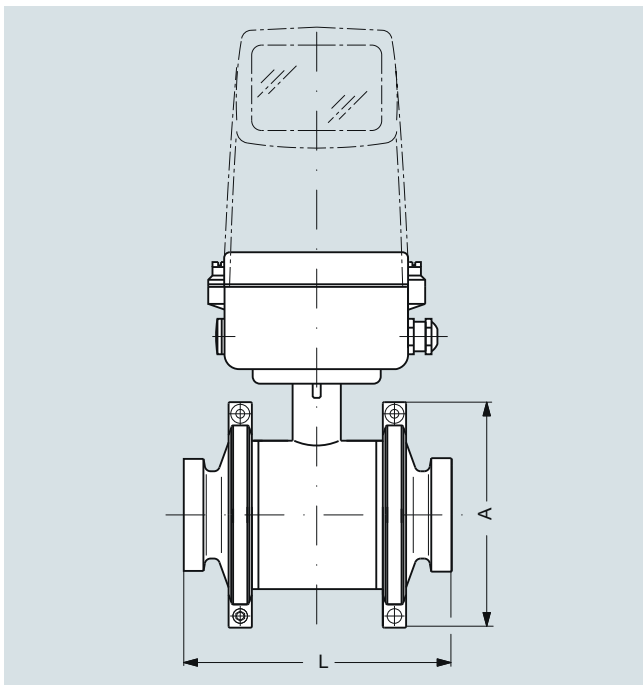

Size		A		L <sup>1)</sup>	
DN	inch	[mm]	[inch]	[mm]	[inch]
10	3/8	99	3.90	146	5.75
15	1/2	99	3.90	146	5.75
25	1	113	4.45	161	6.34
40	1 1/2	126	4.96	176	6.93
50	2	154	6.06	186	7.32
65	2 1/2	165	6.50	223	8.78
80	3	200	7.87	258	10.16
100	4	225	8.86	288	11.34

<sup>1)</sup> The total built-in length "L" is independent of the adapter type selected.